



Company Introduction

J4 CUSTOM

Introduction



Corporation Name	JY Custom Co. LTD.
Founded	1993(Incorporated 2011)
Total Assets	50M\$ USD
Annual Sales ('2018)	Automotive 24M\$ USD Media System(Speaker) 39M\$ USD
CEO	Man-Geum Park
Employees	Automotive : 104 persons Media System : 55 persons Vietnam Factory : 750 persons
Primary Business Area	Automotive Accessories/Speaker, Audio
Address	Headquarter : 642-12 Sansu-ro Gwangju-si Gyeonggi-Do Hanam Office : #206 2F Haus01 Tower, 35, Jojong-daero Hanam-si Gyeonggi-Do Vietnam : Don Van 1 Industrial Park, Duy Tien District, Hanam Province
Phone	TEL : 1566-3833 FAX : 031-798-1501
Home Page	http://www.jycustom.com

History



1993 Jeayoung Precision founded- mold design, injection

1998 manufacturing and distribution
finishing materials for Automotive

2007 manufacturing and distribution
finishing materials Car Navigation, DMB Antenna

2010 Design Team founded
-KOITA
ISO14001 / ISO 9001 Certification
-Certified by Global Industry Certification
Management Innovation Smaller Business,
INNO-BIZ Certification
Certified as Venture company
-by KIBO

2011 INC. JYCUSTOM corporate conversion INC. JY
CUSTOM formed
Starting export to USA/JAPAN

2013 ManYangSu, local subsidiary formed in China

2014 Opening Second plant
- Certified as Management Innovation Smaller Business
, MAIN-BIZ Certification
- by Small and Medium Business Administration

2015 HQ expanded
Automotive Navigation production and distribution
Participated Global sources
Las Vegas SEMA

2016 Automotive Audio production and distribution
Automotive Black Box production and distribution

2017 Participated CES

2018 Participated CES
Taking over Jinyoung G&T's speaker business unit
- Tier 1 television supplier of Samsung Elec.

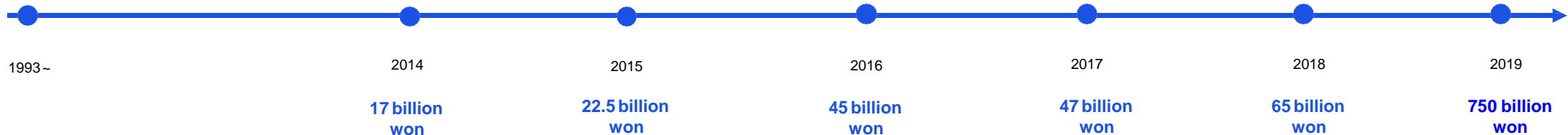

Organization

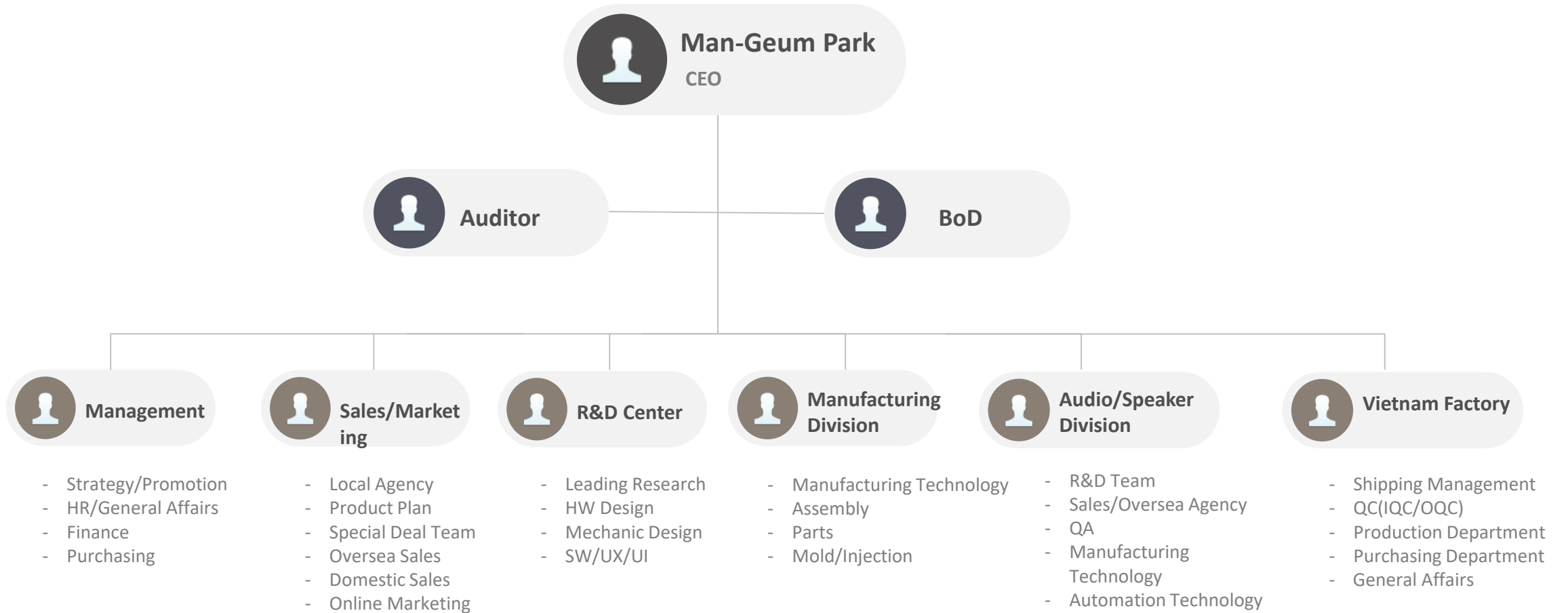

Certification

ISO9001

MAIN-BIZ (Ministry of SMEs and Starups)

INNO-BIZ (Ministry of SMEs and Starups)

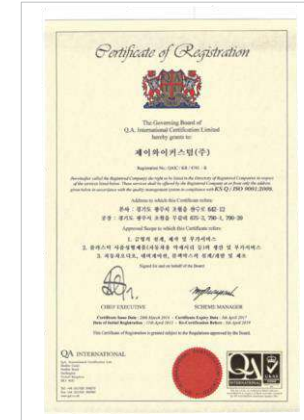
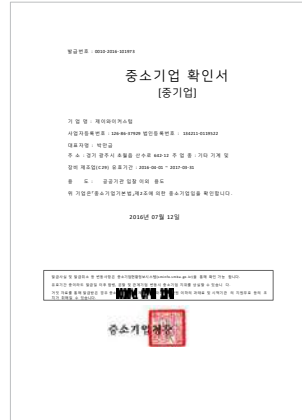

Patents

Interface solution for two different Monitors. N
avigation system with LCD monitor bracket.

Structural solution for external memory device reader on
Navigation system.

Mirroring and controlling solution between touch enabled
monitor and communication device.

Commutation solution between navigation monitor and
communication device.



Certification/Patent



	Date	R/No	Patent Name	Nation
1	2003-03-17	10-0419914	Micro speaker Module and possess Micro Speaker (Patent)	KOREA
2	2002-08-30	10-0419915	Have Dual-Suspension Dynamic Micro Speaker (Patent)	KOREA, USA, JAPAN CHINA, INDIA, EUR OPE
3	2005-02-21	0401728	Micro Speaker Suspension (Design)	KOREA
4	2005-02-21	0401729	Micro Speaker Suspension (Design)	KOREA
5	2004-06-07	10-0640225	Micro speaker Module and use this Micro speaker (Patent)	KOREA
6	2004-02-20	10-0676422	Multi drive and Multi-way Slim flat speaker (Patent)	KOREA
7	2004-02-20	10-0676421	One-Channel Two-way Speaker (Patent)	KOREA
8	2006-09-27	20-0432596	Speaker (practical)	KOREA



CHINA



JAPAN

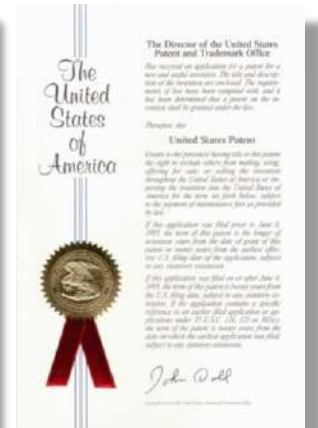

USA



INDIA

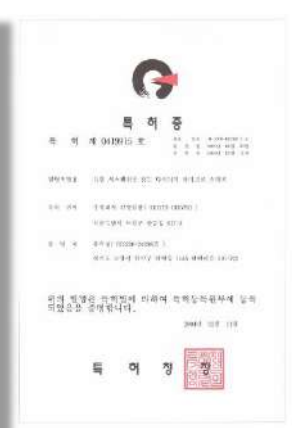

KOREA



EUROPE

Business Revenue

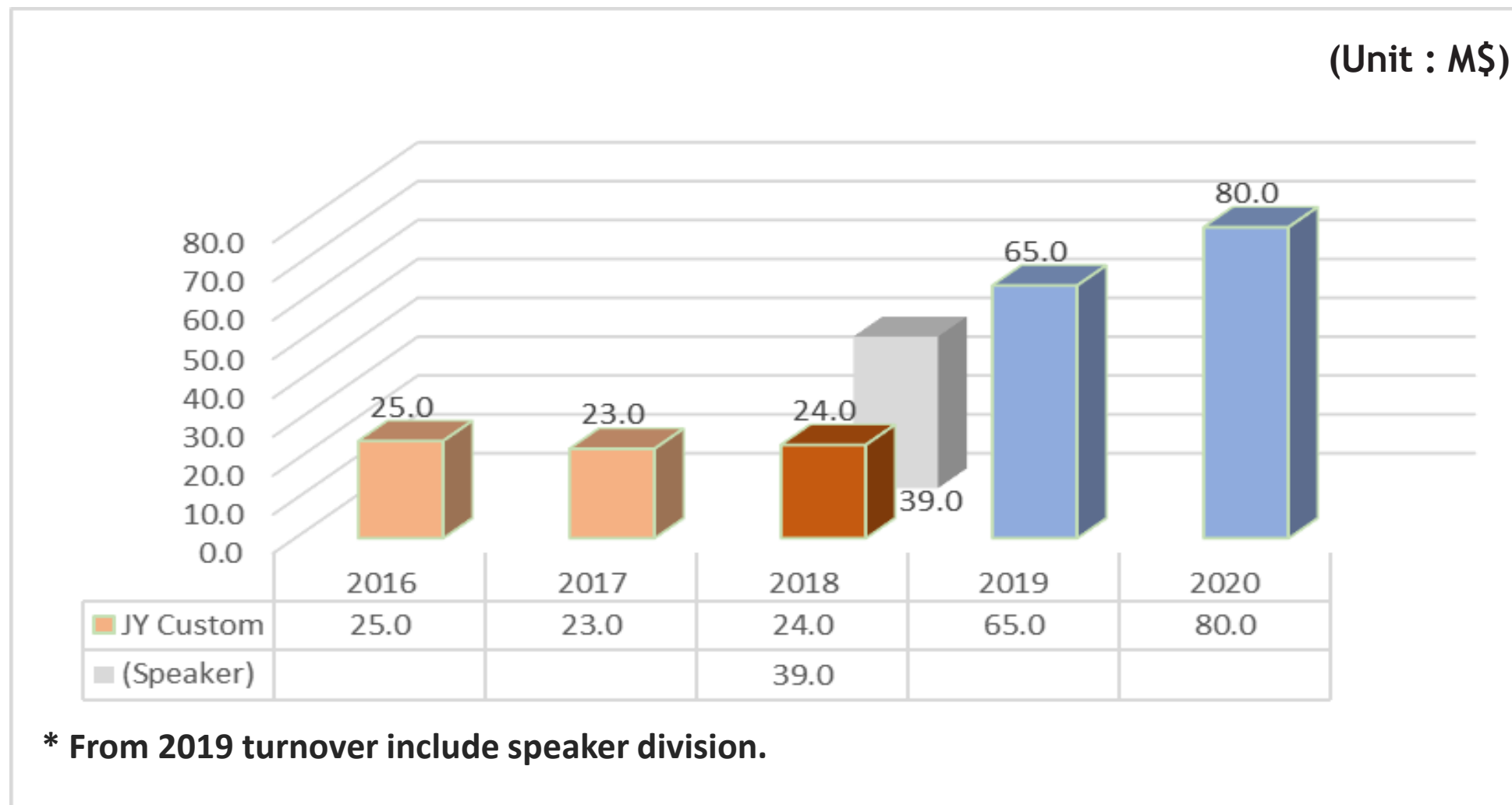



2. Business/Product Overview

Capability

PLAN & DESIGN UX & GUI PRODUCT DESIGN

- Analyze the requirements
- Desice the product SPEC.
- Make the concept
- User experience
- ART3D GUI Solution

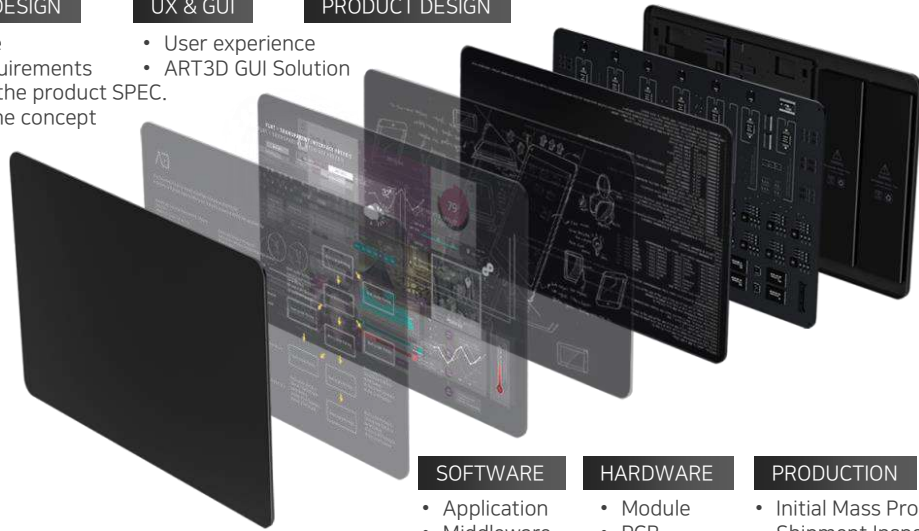

SOFTWARE HARDWARE PRODUCTION

- Application
- Middleware
- Device driver
- Firmware
- Module
- PCB
- Artwork
- Schematic
- Initial Mass Production And Shipment Inspection
- Developed Report

Partner

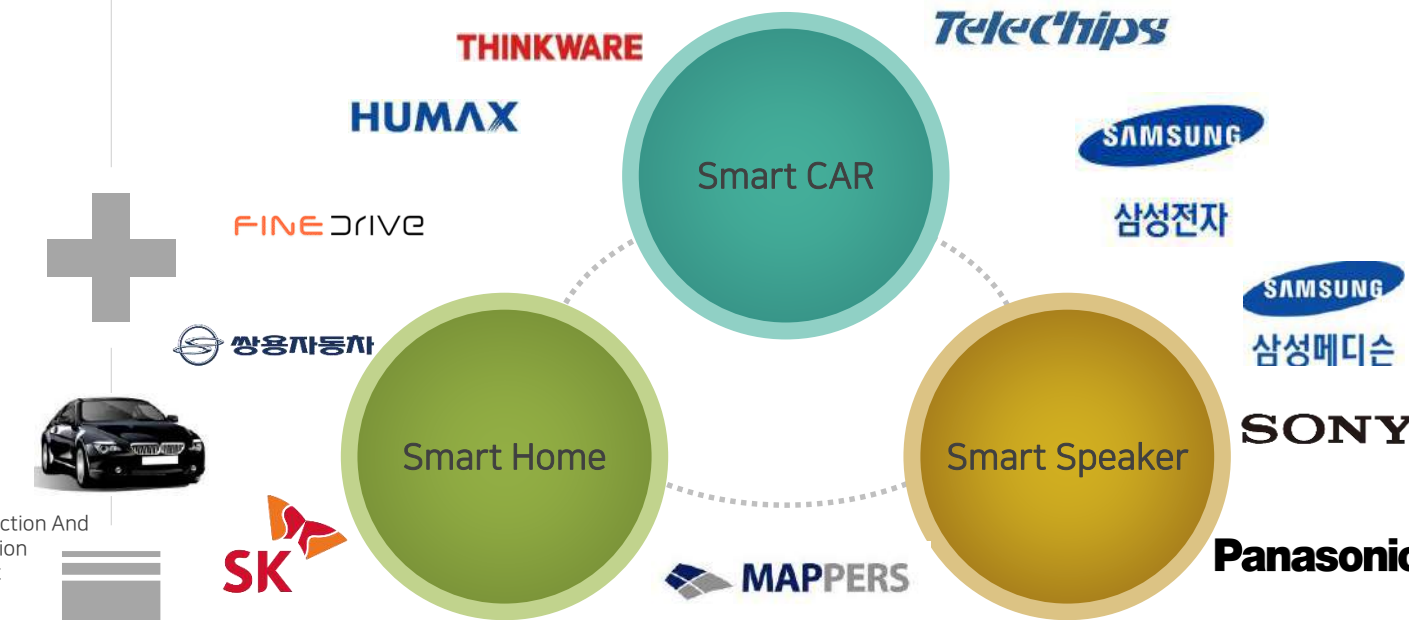

Business Area

SMART CAR



SMART HOME



AUDIO/SPEAKER



Customer Design Process



Product image



1. 3D Scanning
Based on flexibility and precision of equipment, The 3D laser scanning system and multi joint measuring instrument provide excellent measurement.



2. Reverse Engineering
Based on accurate scanning data, we design most optimized Reverse Engineering according to product development goals.

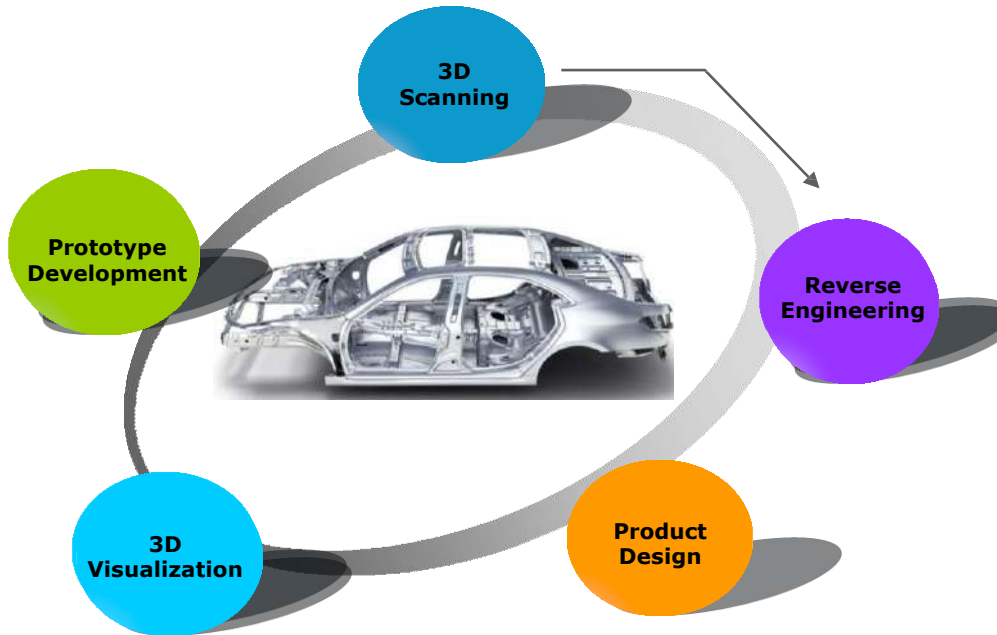
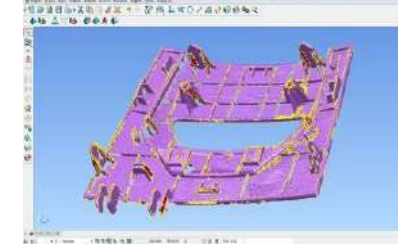

3. Product Design
Using Modeling Program, NURBS, our high-quality designer and engineer design the product.

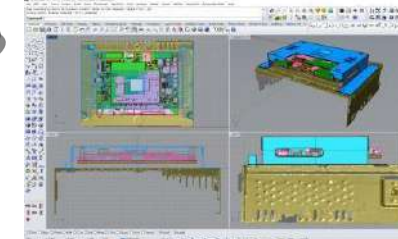

5. Prototype Development
3D printer allows to create large prototype-type models and it increases completeness of mold before it is built, through product validation.



4. 3D Visualization
Make presentations using realistic rendering images of designed products, review designs and solve technical issues.



Core Competency



Real Time Super precision MAP



SK Telecom & T-MAP API
Interface

Global Customization



Support Global MAP

Smart Phone Interface



Mirroring OS independency
Android UIBC support

Smart Sound recognition



Destination , Playback, vehicle
information

Smart visual recognition



People, Things, Lane recognition

Vehicle Information

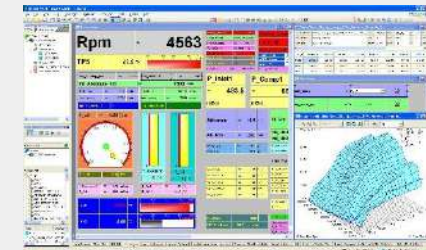

Vehicle ECU , CAN ,
Audio,Air Control Informaton

Core Competency



3D Visual Process



Robotic Vacuum Dual Camera
3D Image Processing

3D Design



3D Design Rendering

Mold/Injection

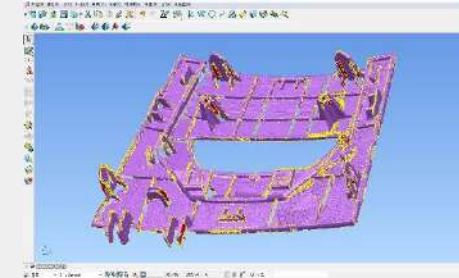

CE Devices Structural Design

Slim/General Unit



Ultra Slim Speaker(10mm ↓)
High Efficiency, Power Speaker
General Dynamic Speaker

Speaker Encloser Design



Resonance attenuation technology
Duct Design
Vibration Analysis

Low Cost Speaker

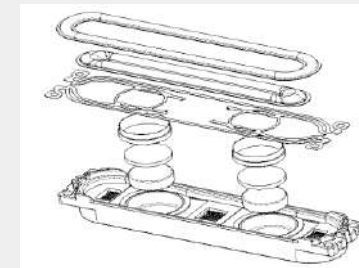

Low Cost & Weight Optimization
Plastic material Injection)

Product Overview

◆ Commercial Navigation

N5000 NAVI
OS : Android

- One of the first navigation system which features HD DMB in Korean market
- Apply Android KitKat OS
- Duplex control mirroring system (Android only)
- Quick Rear view screen
- GPS with the latest U-Blox 8 chipset
- GLONASS Satellite Navigation System etc.



i3000 NAVI
OS : Android

- New Concept Table Navigation
- Android Jelly Bean
- Internet access via Wi-Fi tethering
- Mirroring Using Wi-Fi Data Transport Technology
- Install APP in Android mode
- Customizable Parking line



AVN
OS : Android

- New Concept Separated AVN
- i3000 Navigation+A1000Audio
- I3000 Android navigation ability
- Ultra-small audio with built-in Trip Interface
- Apply Audio function
- Apply pre-amplifier and Integrated Amplifier
- Speed sensitive volume regulation



NBOX (N4000)
OS : Android

- Interface + Settop Integrated Navigation
- Easy upgrade via multi-box
- Button compatibility with OEM hand held remote control
- Safe with PDC and PAS



Apply Quick Rear cam



Product Overview

◆ Accessory

HD BOX

HD DMB / Miracast Box

- Provide service to enable viewing of HD DMB before not received from existing navigation device.
- Strengthen product competitiveness by supporting Miracast.
- AV-OUT & HDMI Two outputs provide various display instrument compatibility.
- Provide convenience by supporting customizing set up Key or remote control function.



※Fit to existing navigation & display devices supporting HD-DMB and Miracast features.

BLACK BOX TouchGO

- FHD & HD Maximum 24fps / Format Free Technology / 3.5" Wide LCD
- high precision 3-axis accelerometer/ Wide recording angle / External GPS / Low-power consumption hardware design / Low Voltage cut off / quick reboot / Large Size Security LED / dedicated viewer for PC



TRIP INTERFACE

- Trip Computer is Vehicle Information System that allows the driver to conveniently operate various information on the vehicle, including audio, as well as various information related to the vehicle.
- SO Drive is a Smart Car Care System that receives data such as fuel economy, mileage, RPM and battery Information through OBD terminal to help identify car condition and maintain it.



ANTENNA

- Audio & TDMB Antenna



Product Overview



◆ Accessory

Neo Auto TailGate System

- Open and close the trunk lid with smart Keys and other factory installed buttons.
- Safety features available to protect users.
- Easy installation.
- Maximize the product.



Dress up Tuning

JY Custom offers products including; Front Grill
Shark Antenna covers Lip Spoilers



Product Overview(Speaker Unit)



FOR SLIM STYLISH DTV DUAL SUSPENSION MULTI DRIVE



A-100-0029-A01

A-100-0026-A01

A-100-0041-A01

Model	Size(m/m)	Use	Imp(Ω)	SPL(dB)	Nom.P(W)	Fo(Hz)
A-100-0029-A01	90 x 15 x 13.T	Front	8	82	10	360
A-100-0026-A01	85 x 20 x 12.4T	Front	6	83	10	160
A-100-0041-A01	90 x 30 x 8.8T	Woofer	8	82	15	160
Conditions			1(KHz)/1(Vrms)	1.0(W)/0.5(M)		Fo(Hz)/1(Vrms)

FOR SLIM STYLISH DTV GENERAL UNIT



JSS-403001

A-100-0169-A01

A-100-0169-A01

Model	Size(m/m)	Use	Imp(Ω)	SPL(dB)	Nom.P(W)	Fo(Hz)
JSS-403001	∅40x30	F/Range	8	79	10	170
A-100-0147-A01	∅70x14.5	Woofer	12	80	10	115
A-100-0169-A01	∅80x17.5	Woofer	3	79	20	110
Conditions			1(KHz)/1(Vrms)	1.0(W)/0.5(M)		Fo(Hz)/1(Vrms)

FOR SLIM STYLISH DTV GENERAL UNIT



JSS-4022001

JSS-5010001

JSS-6542001

Model	Size(m/m)	Use	Imp(Ω)	SPL(dB)	Nom.P(W)	Fo(Hz)
JSS-4022001	∅40x22	F/Range	8	80	5	250
JSS-5010001	∅50x10	Woofer	8	80	10	130
JSS-6542001	∅65x42	Woofer	8	80	15	170
Conditions			1(KHz)/1(Vrms)	1.0(W)/0.5(M)		Fo(Hz)/1(Vrms)

FOR SLIM STYLISH DTV GENERAL UNIT



JSS-7750001

JSS-8080001

JSS-12086001

Model	Size(m/m)	Use	Imp(Ω)	SPL(dB)	Nom.P(W)	Fo(Hz)
JSS-7750001	∅77x50	Woofer	8	83	30	140
JSS-8069001	∅80x69	Woofer	8	79	20	110
JSS-12086001	∅120x86	Woofer	4	82	25	90
Conditions			1(KHz)/1(Vrms)	1.0(W)/0.5(M)		Fo(Hz)/1(Vrms)

Product Overview(Speaker Unit)



FOR SLIM STYLISH DTV

GENERAL UNIT



JSS-8020001



JSS-9025001



JSS-9630001

Model	Size(m/m)	Use	Imp(Ω)	SPL(dB)	Nom.P(W)	Fo(Hz)
JSS-8020001	80x20x26.5	F/Range	6	77	10	350
JSS-9025001	90x25x34.5	F/Range	6	79	10	250
JSS-9630001	96x30x34.5	F/Range	6	79	10	190
Conditions			1(KHz)/1(Vrms)	1.0(W)/0.5(M)		Fo(Hz)/1(Vrms)

FOR HIGH RESOLUTION DOME TWEETER



A-100-0066-B01



A-100-0005-C01



A-100-0137-A01

Model	Size(m/m)	Use	Imp(Ω)	SPL(dB)	Nom.P(W)	Fo(Hz)
A-100-0066-B01	30x16x14	Tweeter	6	90	15	2600
A-100-0005-C01	25x25x5.5	Tweeter	6	90	10	3000
A-100-0137-A01	\varnothing 40x10.8	Tweeter	6	96	10	1300
Conditions			1(KHz)/1(Vrms)	1.0(W)/0.5(M)		Fo(Hz)/1(Vrms)

FOR OLED TV

EXITER SPEAKER UNIT

■ Shape (Size : 40x40x8.9mm)

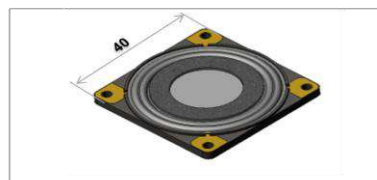

■ Section View

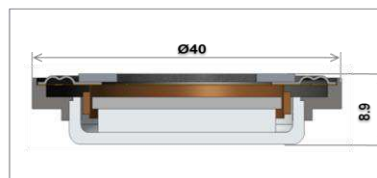

■ Unit structure

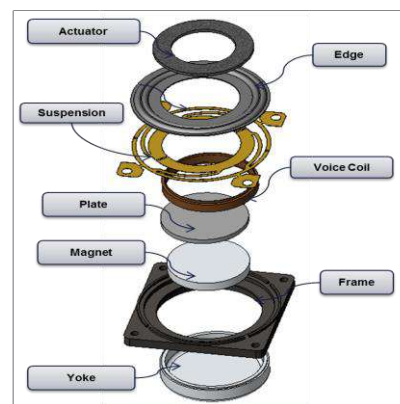

Product Line(Speaker System) **FOR SLIM STYLISH DTV**



GENERAL SPEAKER



JYSA14-1002A

JYSA14-1003A
JSS-031

JYSA14-1007A

JSS-038

JSS-039

Model	Size(m/m)	Use	Imp(Ω)	SPL(dB)	Nom.P(W)	Fo(Hz)	
JYSA14-1002A	279.5 x 137.3 x	2W	6	70	10 (8 Vrms)	WF : 180	
JYSA14-1003A	Model	Size(m/m)	Use	Imp(Ω)	SPL(dB)	Nom.P(W)	Fo(Hz)
JYSA14-1007A	JSS-031	170 x 40 x 30.8T	Full Range	6	82	10	250
Conditions	JSS-038	220 x 68.4 x 35T	Full Range	6	82	10	150
	JSS-039	151 x 66 x 36.6T	Full Range	6	84	10	240
© Copy	Conditions			1(KHz)/1(Vrms)	1.0(W)/0.5(M)		Fo(Hz)/1(Vrms)



Speaker Business Division



Copyright JY CUSTOM All rights reserved.

This Document should be treated as Confidential material of JY CUSTOM.
It contains confidential business information that is the property of JY CUSTOM, and solely for the internal use of JY CUSTOM.
Reproduction, transfer, distribution or storage of part or all of the contents in this document in any form is prohibited without the written consent of JY CUSTOM

Organization of Speaker Biz Division

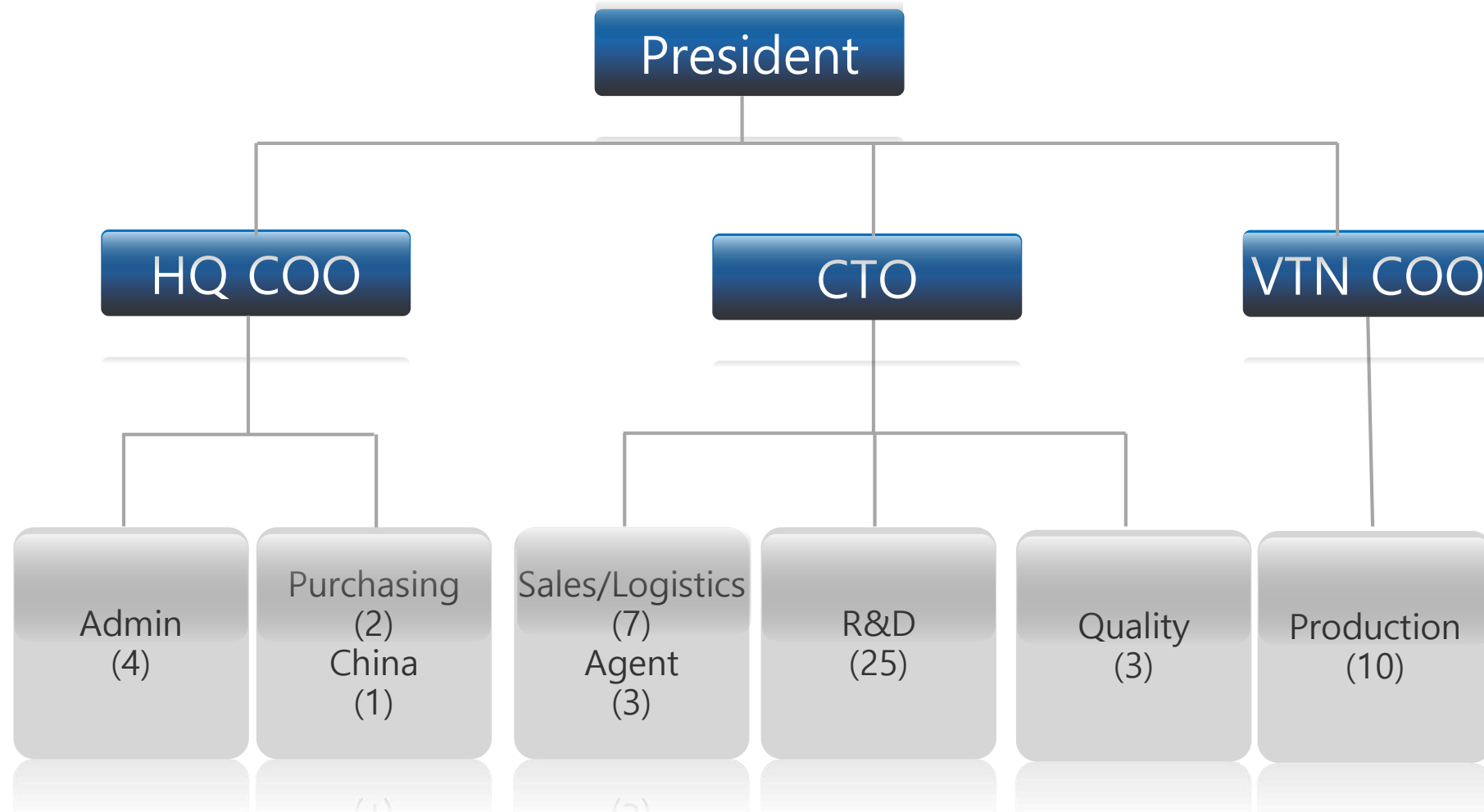

Business History of Speaker Biz Division



To be Global leading sound company in CY2020 through Slim Speaker technology and Products Portfolio

2008 year

Supply to SAMSUNG



2010 year

Supply Speaker Ass'y of LED TV to SAMSUNG (88%)



2013 year

Resister vendor and Supply to PANASONIC/TOSHIBA



2019 year

JY Custom invest factory expansion and automation



2009 year

Register vendor for SAMSUNG Supply Speaker unit of LED TV to SAMSUNG

2012 year

Acquire 1st development right for PHILIPS

2014 year

Customer portfolio with Global company. New item line-up and sales promotion

2020 year

Jump up as leading company (Turn over target: 138M\$)

HQ & Oversea Location



Company Name	Location	Item	Scale	Max capacity	
			Persons	Month	Year
Hanam Office	Hanam-Si	Speaker Division	50		
Overseas Factory	Hanoi, Vietnam	Speaker Ass'y	700	1.5M	18M

Slim/General Unit



Ultra Slim Speaker(10mm ↓)
High Efficiency, Power Speaker
General Dynamic Speaker

Speaker Encloser Design

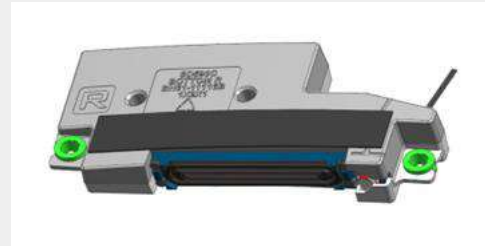

Resonance attenuation technology
Duct Design
Vibration Analysis

Low Cost Speaker



Low Cost & Weight Optimization
Plastic material Injection)

Excellent Business Experience

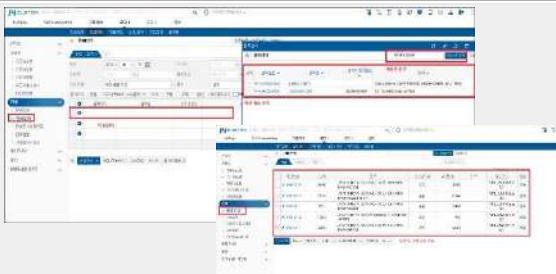

Mass Production
Supply Management(ERP)
Purchasing Power based on Quantity
Quality Control

Factory Automation



Setup Automated Unit Ass'y Line
(~ July of 2019)

In House Design/Manufacture



- Mold Design/making
- Automated Plastic Injection
- Jigs/Mockup design/manufacture
- Ultrasonic welding machine

Unit Development Plan



◆ Slim Speaker

量産中



高さ : 12~18mm
Fo : 110Hz
Power : 10W
音圧 : 85dB

2019年開発



高さ : 7~10mm
Fo : 150Hz
Power : 10W
音圧 : 85dB

2020年開発



高さ : 5mm
Fo : 150Hz
Power : 7W
音圧 : 80dB

Unit Development Plan



◆ General Speaker

2019



* 幅 : 30mm~40mm
* 組立方法 : 既存方式
- 磁気回路
- Cloth Damper
- Tinsel Wire Soldering

2019~2020

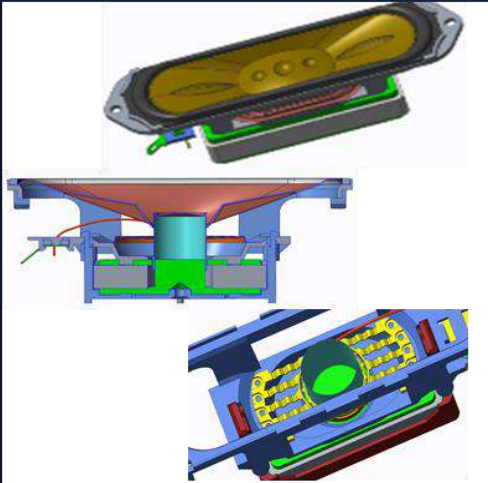

*幅 : 25mm
*組立型構造
- 磁気回路
- 溶着Damper

2020 ~



*幅 : 25mm未満
*Eco組立構造
- Non接着磁気回路
- Non接着Damper or Damperless
- 成型Edge振動板
- Non Soldering Terminal

Production Line(Vietnam Hanoi)



Unit Ass'y Line (Auto soldering)



Unit Ass'y Line



Unit Ass'y Line



SET Ass'y Line



Unit MC Ass'y (Automatic)



Unit Ass'y Line

Investment in factory expansion



◆ New Investment in Vietnam Factory '2019



Automated Plastic Injection(13 machine)

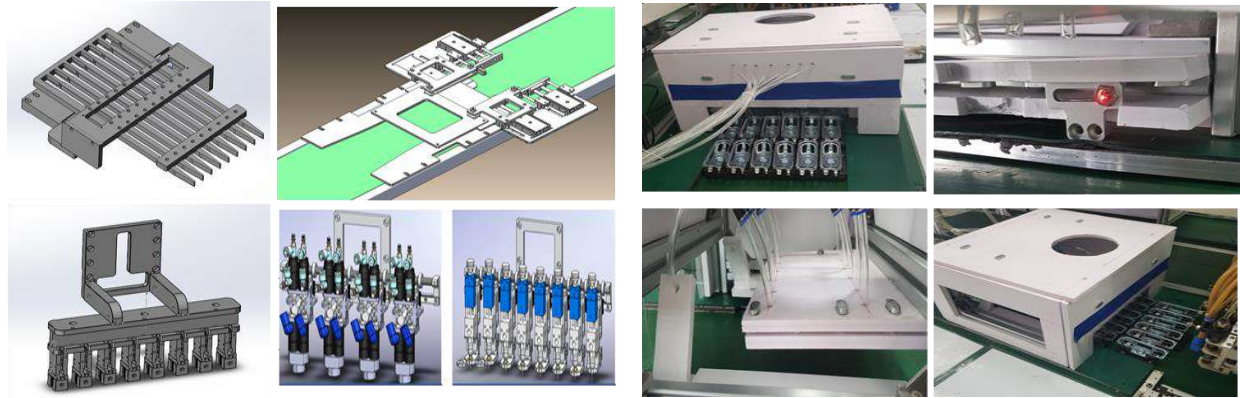

New automated Unit Ass'y Line (2,200 Unit/hr → 3,200 Unit/hr)



Jigs/Mockup manufacturing machine(In-House)



Ultrasonic welding machine(In-House)

Attachment: General vs. Slim Speaker

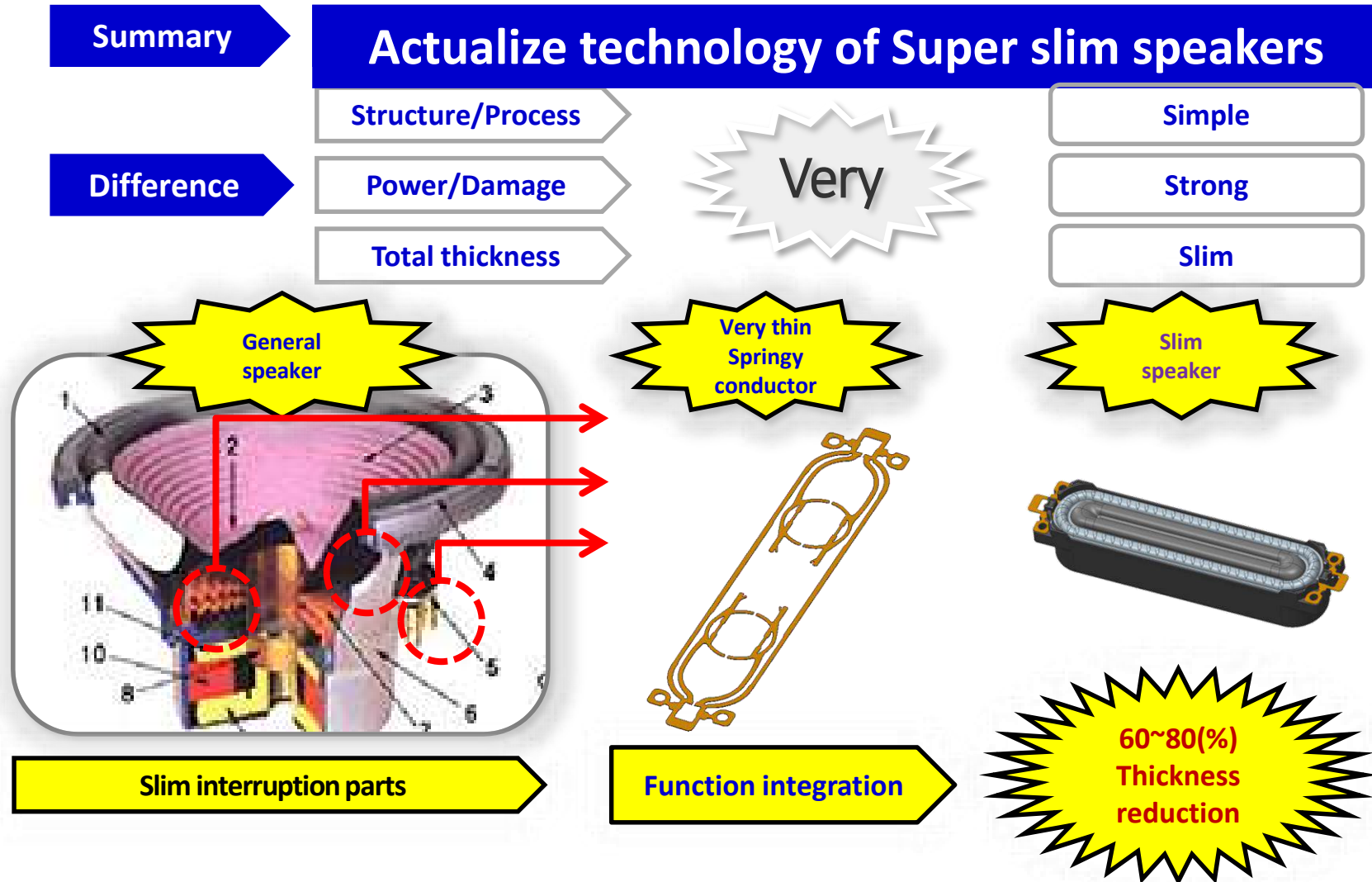

Attachment : Core Architecture of Speaker Unit

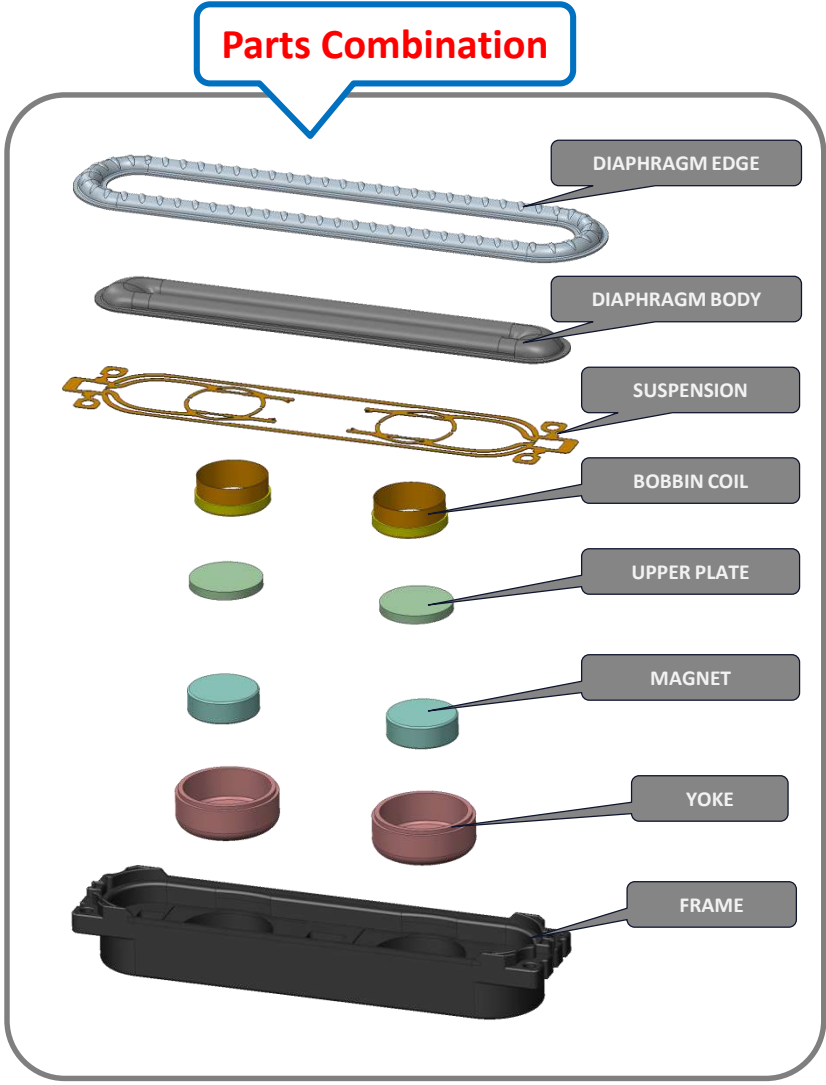
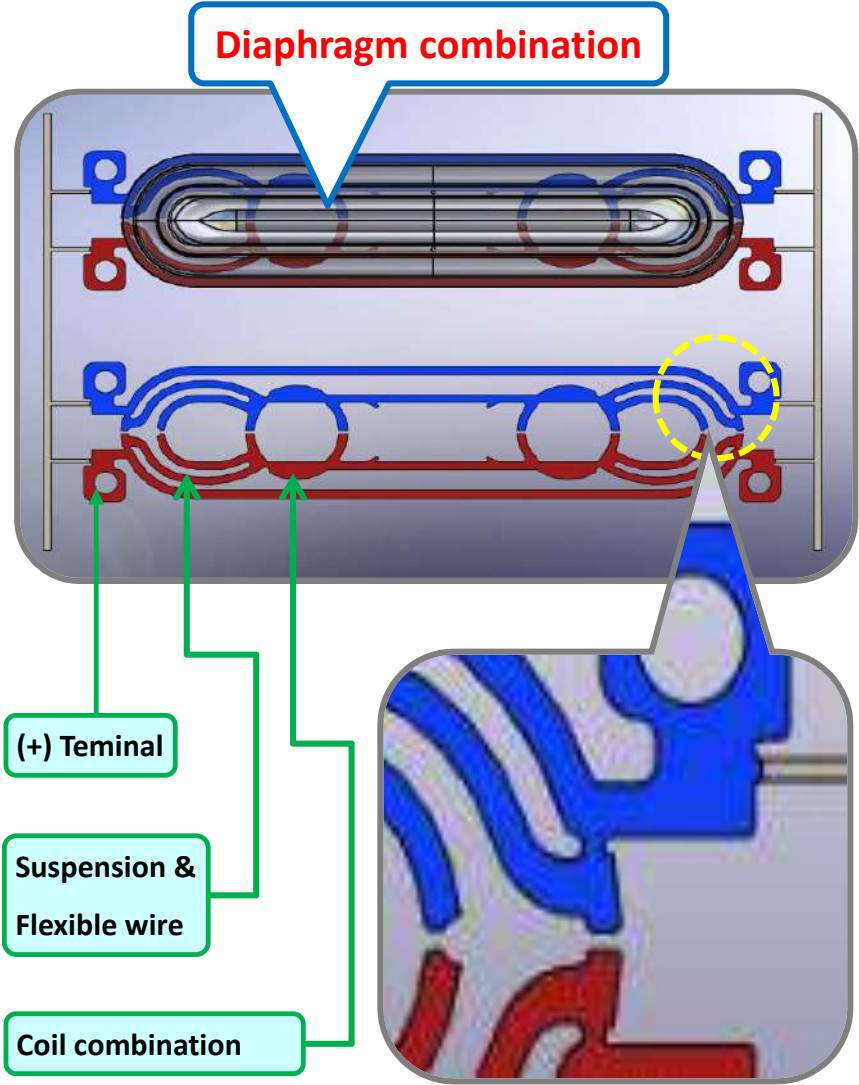

Attachment : Business case

- 7100~7500 / 8000 / Q8 and Etc.
- Q'ty of Sales : 9,000k Set / Year



- High-End Model : DX850F Model and Etc.
- Q'ty of Sales : 500k Set / Year



- High End Model : X93E
- Q'ty of Sales : 300K Set / Year

X940E / X930E | LED | 4K Ultra HD | High Dynamic Range (HDR) | Smart TV (Android TV™)

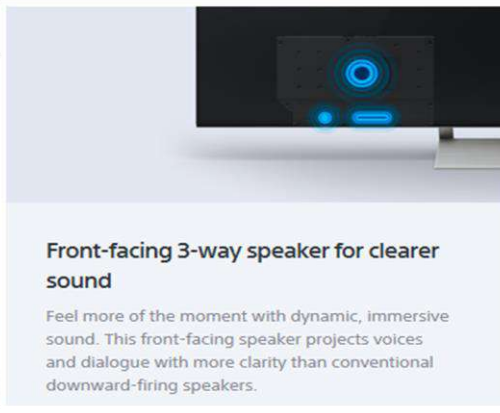

- High-End Model : Z20X Model and Etc.
- Q'ty of Sales : 200k Set / Year

低音から高音までクリアな音声が楽しめる。
大容量バスレフ型ボックススピーカー





THANK YOU



Copyright JY CUSTOM All rights reserved.

This Document should be treated as Confidential material of JY CUSTOM.
It contains confidential business information that is the property of JY CUSTOM, and solely for the internal use of JY CUSTOM.
Reproduction, transfer, distribution or storage of part or all of the contents in this document in any form is prohibited without the written consent of JY CUSTOM